









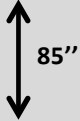

THE 5 VERTICAL SUPPORT POSTS: THE PILLARS OF THE FRAME
LES 5 POTEAUX DE SOUTIEN VERTICAUX: LES PILIERS DE L'ARMATURE

 THE 5 VERTICAL SUPPORT POSTS WITH BASES LES 5 POTEAUX DE SOUTIEN VERTICAUX AVEC BASES		
	<p>Metal pins (K) must ONLY be installed on the 5 vertical support posts. <i>Les goupilles de métal (K) doivent être posées UNIQUEMENT sur les 5 poteaux de soutien verticaux.</i></p>	Pages 6, 12
	<p>Carabiners (G1) of the straps must ONLY be installed on the C-CLIPS (C) securing the 5 vertical support posts. <i>Les mousquetons (G1) des sangles doivent être installés UNIQUEMENT sur les C-CLIPS (C) des 5 poteaux de soutien verticaux.</i></p>	Pages 7, 13
	<p>It is important that the horizontal beam be levelled as much as possible. Adjust the vertical posts accordingly. <i>Il est important que la poutre horizontale soit, le plus possible, de niveau. Ajuster les poteaux verticaux en conséquence.</i></p>	Pages 6, 12
	<p>The vertical support posts require a height of 85 inches. It is recommended that this height be maintained to ensure greater frame stability and achieve the proper pitch to allow snow to slide off. <i>Les poteaux de soutien verticaux doivent avoir une hauteur de 85 pouces. Il est recommandé de maintenir cette hauteur afin d'assurer un maximum de robustesse à l'armature et d'obtenir la meilleure pente possible pour que la neige s'écoule.</i></p>	Pages 6
	<p>The distance between the 5 vertical support posts must be more or less equal in order to have greater stability (they are the 5 pillars of the frame). <i>L'espace entre les 5 poteaux de soutien verticaux doit être le plus équilibré possible pour assurer une bonne stabilité (puisque'il s'agit des 5 piliers de l'armature).</i></p>	Pages 12

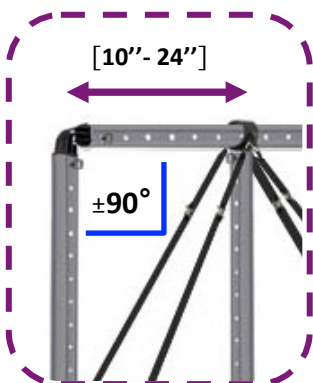





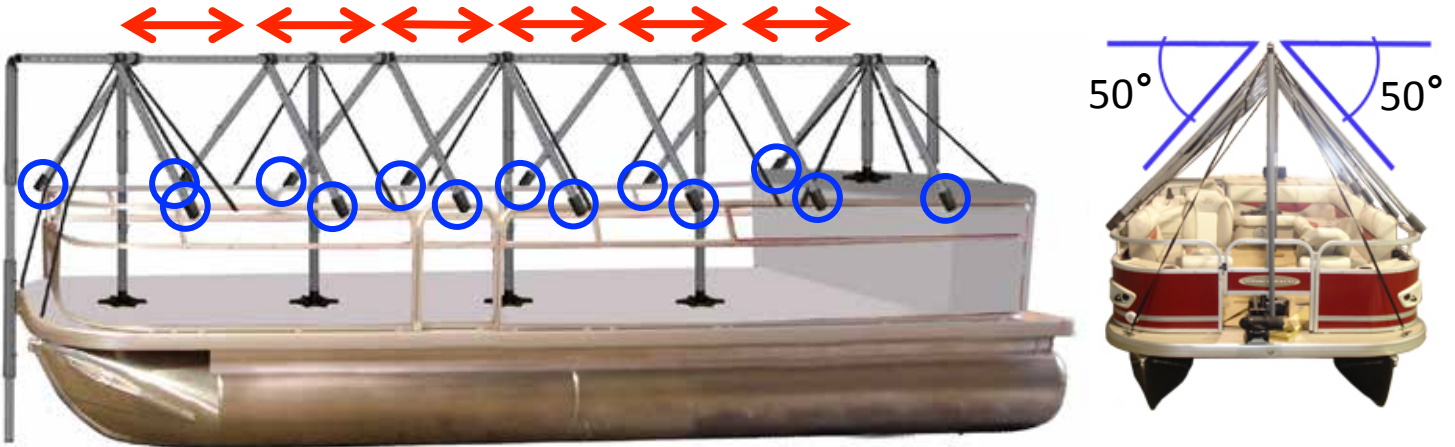

 THE 2 VERTICAL CONNECTORS WITHOUT BASE: front & back LES 2 EMBRANCHEMENTS VERTICAUX SANS BASE: avant & arrière		
	<p>Leave a 10 to 24 inch maximum overhang past the 2 vertical support posts with base (front & back) so that the horizontal beam remains secure. <i>Les 2 embranchements verticaux sans base (avant & arrière) doivent être installés à chacune des extrémités de l'armature à une distance de 10 à 24 pouces maximum des poteaux de soutien avec base (avant et arrière) afin d'assurer la stabilité de la poutre horizontale.</i></p>	Page 9
	<p>Make sure that each extremity (front and back) ends at a ±90° angle. <i>Les 2 embranchements verticaux sans base (avant et arrière) doivent former un angle de ±90° avec la poutre horizontale.</i></p>	Page 10

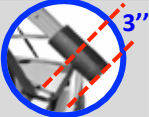

**THE 7 SETS OF LATERAL CONNECTORS
 LES 7 PAIRES D'EMBRANCHEMENTS LATÉRAUX**

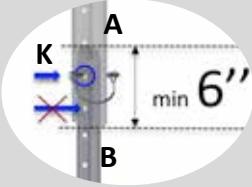
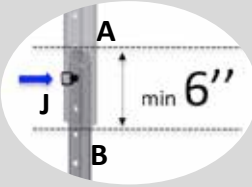
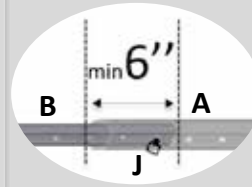

 THE LATERAL CONNECTORS : 7 SETS LES EMBRANCHEMENTS LATÉRAUX : 7 PAIRES		
	<p>The space between the lateral posts must be as equal as possible to ensure greater stability and for a better weight distribution once the tarpaulin is on. <i>L'espace entre les embranchements latéraux doit être le plus équilibré possible afin d'assurer une meilleure repartition des charges lors de l'installation de la toile.</i></p>	Page 16
	<p>Foam protectors (H) must rest on the edge of the watercraft overhanging the edge by about 3 inches. <i>Les embouts de protection (H) doivent s'appuyer sur le rebord de l'embarcation et dépasser d'environ 3 pouces.</i></p>	Page 17
	<p>Foam protectors (H) must overhang the AB post by about 2 inches in order to properly protect the tarpaulin. <i>Chaque embout de protection (H) doit dépasser d'environ 2 pouces l'embranchement latéral AB pour bien protéger la toile.</i></p>	Page 15
	<p>If all previous steps are taken into account, the angle for the slope should be approximately 50 degrees. It is preferable to maintain this angle to have the best slope possible allowing the snow to slide off. <i>En respectant les étapes précédentes, l'angle d'inclinaison des embranchements latéraux sera d'environ 50 degrés. Il est préférable de maintenir cet angle d'inclinaison afin d'assurer la meilleure pente possible pour que la neige s'écoule.</i></p>	Page 17

 OVERLAPING of the A and B tubes CHEVAUCHEMENT des tubes A et B			
			<p>For each of these steps, it is important to have a minimum 6 inch overlap of the A and B tubes in order to have the best security possible. <i>Pour chacune de ces étapes, il est important d'appliquer un minimum de 6 pouces de chevauchement des tubes A et B afin d'avoir une solidité accrue.</i></p>
Pages 6, 12	Pages 10, 16	Page 9	



THE SELF LOCKING STRAPS
LES SANGLES AUTOBLOQUANTES

	<p>To ensure proper assembly of straps: Thread G2 through the clip at the end of G1 from the bottom, then pull hard from both ends. G2 should not slip; if it does, remove G2, turn the clip at the end of G1 over so that the teeth of the clip are facing upward, then thread G2 through the clip from the bottom again. Test resistance by pulling strap from both ends. WARNING: As you pull on both ends of the strap, make sure that G2 does not slip! If it does, remove G2, turn the clip at the end of G1 over so that the teeth of the clip are facing upward, then thread G2 through the clip from the bottom again. (see Step 1)</p> <p><i>S'assurer que les sangles soient enfilées dans le bon sens: la partie G2 doit être enfilée dans la partie G1 de manière à ce qu'il y ait une résistance lorsque vous tirez sur les 2 extrémités de la sangle (G1 et partie libre de G2). ATTENTION: Si vous n'arrivez pas à avoir une résistance et que la sangle glisse, enlevez la partie G2, retournez-la et recommencez de nouveau. (voir Étape 1)</i></p>	<p>Pages 4, 8, 14</p>
	<p>The tension in the self locking straps on each side of the vertical support posts must remain tight and equal to ensure maximum stability. <i>La tension des sangles doit être ajustée uniformément de chaque côté des poteaux de soutien verticaux afin d'assurer une bonne stabilité.</i></p>	<p>Pages 8, 14</p>
	<p>Ensure that gates on the carabiners are properly closed. <i>Assurez-vous que les mousquetons soient bien enclenchés.</i></p>	<p>Pages 8, 14</p>

THE FRONT VERTICAL CONNECTOR WITHOUT BASE
L'EMBRANCHEMENT VERTICAL AVANT SANS BASE

	<p>We recommend that the FRONT vertical connector without base (AB + AB-r) (the post resting on the ground) be secured to the tongue of the trailer with a rope.</p> <p><i>Nous recommandons que l'embranchement vertical AVANT sans base (AB + AB-r) (qui est appuyé au sol) soit attaché à la tige de la remorque par une corde.</i></p>	<p>Page 17</p>
--	--	----------------

EXTRA PROTECTION
PROTECTIONS SUPPLÉMENTAIRES

	<p>We recommend using extra protective measures for fragile surfaces that may come into contact with the bases, the posts and/or the straps. For example: place a swatch of carpet and a piece of plywood under the bases (or the posts) to protect the watercraft's upholstery.</p> <p><i>Nous recommandons de protéger toute surface fragile qui sera en contact avec les bases, les poteaux et/ou les sangles. Par exemple: déposez un morceau de tapis et une planche de bois sous les bases (ou les poteaux) afin de bien protéger le revêtement de votre embarcation.</i></p>
--	---

DURING INSTALLATION OF TARPULIN:

- It is your responsibility to prevent the Navigloo tarpaulin from coming into direct contact with protruding components that may create friction, which could potentially damage or perforate it. (i.e. snaps for canvas or Bimini top anchor points) ***Damage caused by unpadded components that wear or perforate the tarpaulin is not covered under the conditions of the limited warranty.**
- Take extra precautions to prevent the grommets on the tarp from damaging the hull of your watercraft.

LORS DE L'INSTALLATION DE LA TOILE:

- *Il est de votre responsabilité de vous assurer que la toile ne puisse être en contact avec toute composante qui pourrait endommager ou perforer la toile par friction causée par le vent ou autre. (Exemples : les boutons-pression d'une toile rapide, les points d'ancrage d'un toit Bimini, etc.) ***La garantie sur la toile ne couvre pas les dommages causés par toute composante non protégée qui pourrait endommager ou perforer la toile.***
- *Assurez-vous que les œillets de la toile n'abîmeront pas votre embarcation.*

It is your responsibility to add **extra protection** to your watercraft when necessary (Example: **motor cover**, etc.)

*Il est de votre responsabilité d'apporter les **protections supplémentaires** que vous jugerez appropriées à votre embarcation. (Exemple: **housse de protection pour moteur hors-bord**, etc.)*